

Note: The pictures in the Product Specification are for reference only, please refer to the actual product.



PRODUCT SPECIFICATION

SILICONE NEON STRIP

OMNI 360° NEON

- 360° Lighting

OMNI 25
LL-NR25



- Unique optical light distribution structure design, 360° emitting uniform without shadow.
- Integrated extrusion molding process, high light transmittance, environment-friendly silicone material.
- Excellent toughness, stylish appearance, elegant design
- Salt resistance, acid & alkali corrosion resistance, UV and fire resistance.
- Ambient temperature: -25°C~60°C; Storage temperature: 0°C~60°C.

Dimension structure (Unit: mm)

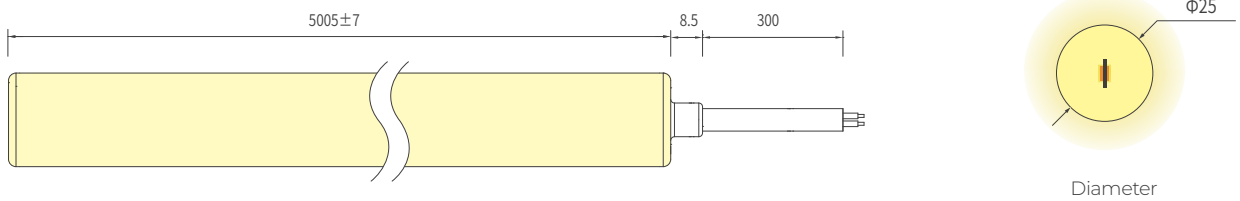

Electrical Parameter

Voltage	LED PIN Temperature	Storage Temperature	Ambient Temperature
DC24V	Max. 65 C	-25 C ~ 60 C	Min.-25°C Max(Table below)

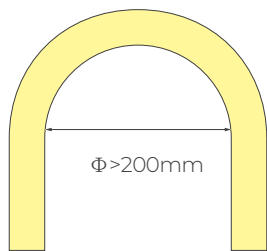

Minimum bending diameter

Specification

Power (w/m)	Efficacy (lm/w) @4000K	Max Ambient Temperature
5	59	55°C
10	55	45°C

Due to the tolerance of the production and electrical components, output value and electrical power can vary up to 10%

Length Standard

Length Range (M)	Final Length (mm)			Tolerance (mm)
	Integral end cap	Silicone end cap	Metal End Cap	
0<Neon Strip(L)≤5	L+5	L+5	L+9	±7

Light Distribution Curve

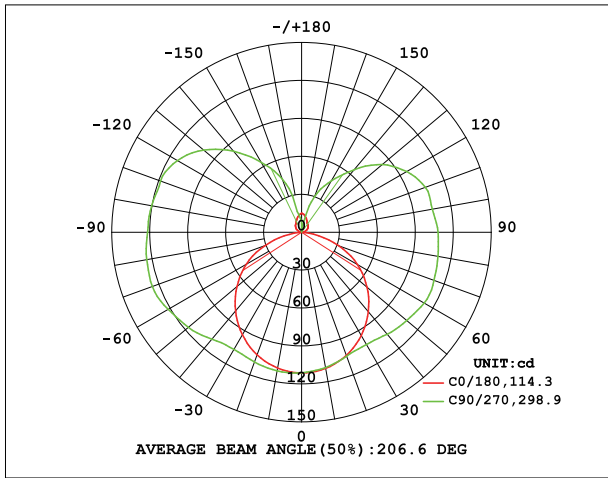

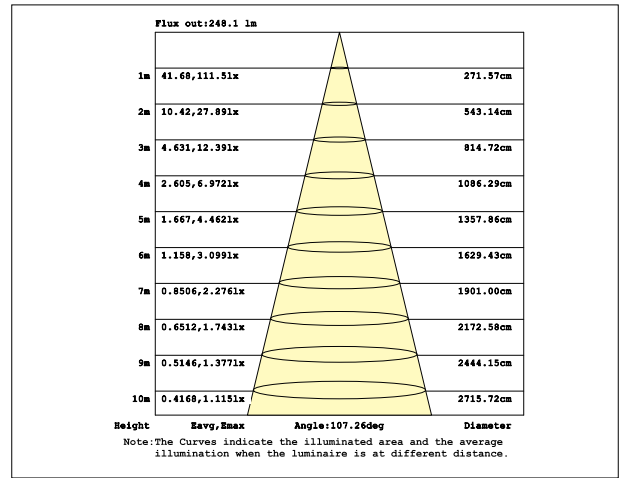

Illuminance curve





Note: The above data is based on 24V, 10W/M, single colour with 4000k colour temperature. If you need IES files for other types. Please contact our sales department.

Parameter Table



 Resistant Saltwater

 Resistant To Solvents

 UV Protection

 Warranty 5 Years

 IK 10

 Voltage 24v DC

Single color

CCT(K)	Ra	Voltage	Power(W)	Lumen (LM/M)	Efficiency (LM/W)	Max Run Length (M)	CC/CV
2400±150	≥90	DC24V	12	636	53	10	CC
2700±150	≥90	DC24V	12	624	52	10	CC
3000±150	≥90	DC24V	12	636	53	10	CC
3500±200	≥90	DC24V	12	720	60	10	CC
4000 ⁺⁴⁰⁰ ₋₂₀₀	≥90	DC24V	12	660	55	10	CC
5000 ⁺⁵⁰⁰ ₋₃₀₀	≥90	DC24V	12	720	60	10	CC
6000±500	≥90	DC24V	12	696	58	10	CC

- The maximum series length refers to the maximum length of the light strip with single-end power supply in series under the standard 30CM cable.
- The given color temperature is the temperature of finished product.
- The given data are typical values due to the tolerances of the production process and the electrical components, values for light output and electrical power can vary up to 10%.
- All products can be dimmed; the dimmer's voltage should conform to the rated voltage of the led light.
- The output frequency of the dimmer of the constant-current led light should be less than 2K Hz, and the output PWM can control the led light.

Cable Lead Option (Unit: mm)

Integral End Cap (IP67)

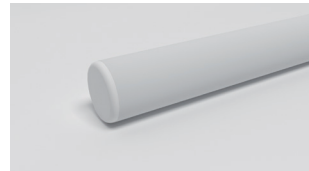
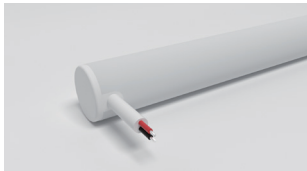
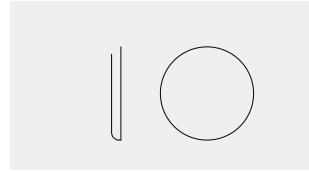
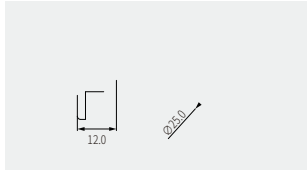
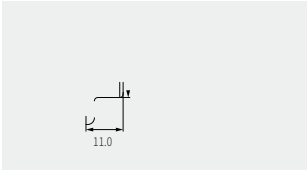

Front Cable Entry

Side Cable Entry

Closed End cap

Silicone end cap (IP65)

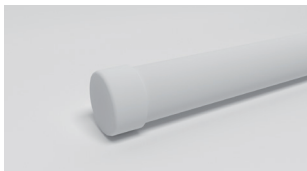
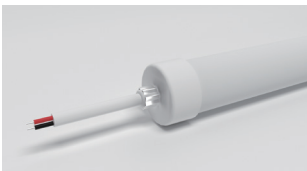
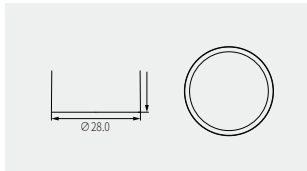
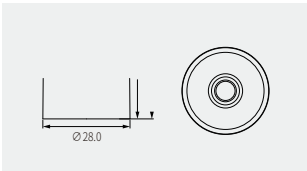

Front Cable Entry

Closed End cap



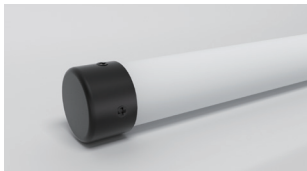
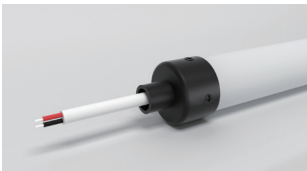
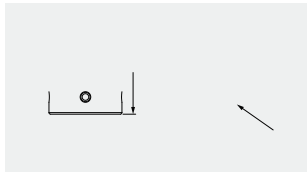
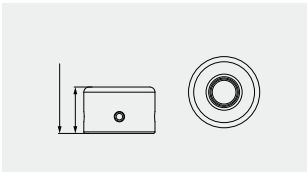



Metal End Cap(IP65) The metal guard coil is unavailable if fitted the metal end cap

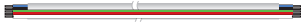

Front Cable Entry

Closed End cap

Cable

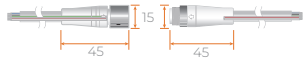
Cable Type	Schematic Diagram	Specification	Core	Electrical Properties
Silicone Cable		OD: 6.0mm / Inner core: 20AWG	●●	Red V+, Black V-
		OD: 6.0mm / Inner core: 20AWG	●○●	Black V+, White W, Yellow WW
		OD: 6.0mm / Inner core: 20AWG	●●●●	Black V+, Blue B, Green G, Red R
		OD: 6.4mm / Inner core: Red/Black--20AWG Green/Blue/White--22AWG	●○●●●	Black V+, White W, Blue B, Green G, Red R
Waterproof Connector with Silicone Cable		OD: 6.0mm / Inner core: 20AWG M12Male / Female connecto	●●	Red V+, Black V-
		OD: 6.0mm / Inner core: 20AWG M12Male / Female connecto	●○●	Black V+, White W, Yellow WW
		OD: 6.0mm / Inner core: 20AWG M12Male / Female connecto	●●●●	Black V+, Blue B, Green G, Red R
		OD: 6.4mm / Inner core: Red/Black--20AWG Green/Blue/White--22AWG M12Male / Female connecto	●○●●●	Black V+, White W, Blue B, Green G, Red R

Product accessories



-Name: R25 - Surface mounting with open PC clips
 -Model: R25-IA01
 -Attachment: Transparent PC mounting clips, Tapping screws, Expandable rubber plugs



-Name: R25 - Surface mounting with PC profile
 -Model: R25-IA02
 -Attachment: Transparent PC mounting profile, Tapping screws, Expandable rubber plugs
Note: Using Transparent PC mounting profile will cause the neon body to compress and stretch, resulting in a dark area at the tail!



-Name: R25 - "—" type hanging mounting with open PC clips
 -Model: R25-IA03
 -Attachment: Transparent PC mounting clips, Kit of hanging rope, Screws



-Name: R25 - "—" type hanging mounting with PC profile
 -Model: R25-IA04
 -Attachment: Transparent PC mounting profile, Kit of hanging rope, Screws
Note: Using Transparent PC mounting profile will cause the neon body to compress and stretch, resulting in a dark area at the tail!



-Name: R25 - "I" type hanging mounting
 -Model: R25-IA05
 -Attachment: Kit of "I" type hanging mounting, Tapping screws, Expandable rubber plugs



-Name: R25 - "U" type hanging mounting
 -Model: R25-IA06
 -Attachment: Kit of "I" type hanging mounting, Tapping screws, Expandable rubber plugs



-Name: R25 - "I" type hanging mounting with rope
 -Model: R25-IA07
 -Attachment: Kit of "I" type hanging mounting with rope, Tapping screws, Expandable rubber plugs

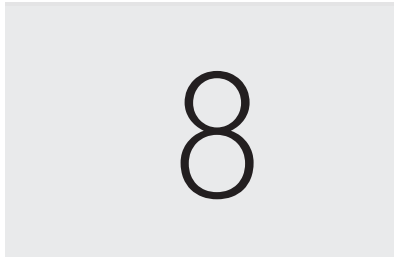

-Name: R25 - Connector with side outlet
 -Model: R25-IA08
 -Attachment: Metal connector with side outlet, Tapping screws



-Name: R25 - Connector
 -Model: R25-IA09
 -Attachment: Metal connector, Tapping screws

Product accessories



-Name: R25 - Surface mounting with closed PC clips
 -Model: R25-IA10
 -Attachment: "Ω" type transparent PC clips,Transparent PC pedestals with one hole,Tapping screws,Expandable rubber plugs



-Name:R25 - " type hanging mounting with closed PC clips
 -Model:R25-IA11
 -Attachment:"Ω" type transparent PC clips,Transparent PC pedestals with one hole,Kit of hanging rope, Machine screws

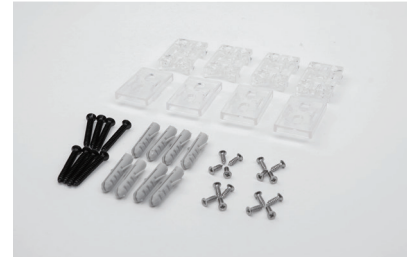

-Name: R25 - Surface mounting with concealed PC clips
 -Model: R25-IA12
 -Attachment: Transparent PC pedestals with two holes,Transparent PC pedestals with five holes,Tapping screws,Tapping screws,Expandable rubber plugs



-Name: R25 - " type hanging mounting with concealed PC clips
 -Model: R25-IA13
 -Attachment: Transparent PC pedestals with five holes,Tapping screws,Kit of hanging rope,Machine screws



-Name: R25 - " type adjustable hanging mounting with open PC clips
 -Model: R25-IA14
 -Attachment: Transparent PC mounting clips,Machine screws,Kit of telescopic rod



-Name: R25 - " type adjustable hanging mounting with PC profile
 -Model: R25-IA15
 -Attachment: Transparent PC mounting profile,Machine screws,Kit of telescopic rod
Note: Using Transparent PC mounting profile will cause the neon body to compress and stretch, resulting in a dark area at the tail!



-Name: R25 - " type adjustable hanging mounting with closed PC clips
 -Model: R25-IA16
 -Attachment: "Ω" type transparent PC clips,Transparent PC pedestals with one hole,Kit of telescopic rod



-Name: R25 - " type adjustable hanging mounting with concealed PC clips
 -Model: R25-IA17
 -Attachment: Transparent PC pedestals with five holes,Tapping screws,Kit of telescopic rod,Machine screws



-Name: R25 side outlet transparent connector
 -Model: R25-IA18
 -Attachment: Screws,PMMA transparent side outlet connector

Product accessories



-Name: R25 side outlet transparent connector with lifting rope
 -Model: R25-IA19
 -Attachment: Screws,Kit of hanging rope,
 Expandable rubber plugs,Tapping
 screws,PMMA transparent side outlet
 connector;



-Name: R25 transparent connector
 -Model: R25-IA20
 -Attachment: Screws,PMMA transparent connector;



-Name: R25 transparent connector with lifting rope
 -Model: R25-IA21
 -Attachment: Screws,Kit of hanging rope,
 Expandable rubber plugs,Tapping
 screws,PMMA transparent connector;



-Name: R25-Horizontal hanging circular tube 1M
 -Model: R25-IA22
 -Attachment: Screws,Kit of hanging rope,
 Expandable rubber plugs,Tapping
 screws,PMMA transparent circular tube;



-Name: R25-Horizontal hanging circular tube 2M
 -Model: R25-IA23
 -Attachment: Screws,Kit of hanging rope,
 Expandable rubber plugs,Tapping
 screws,PMMA transparent circular tube;



-Name: R25-Double-notch Fastener
 -Model: R25-IA24
 -Attachment: Double-notch Fastener,
 Expandable rubber plugs,Tapping screws



-Name: R25-Single-notch Fastener
 -Model: R25-IA25
 -Attachment: Single-notch Fastener,
 Expandable rubber plugs,Tapping screws

R25 - Surface mounting with open PC clips(R25-IA01)

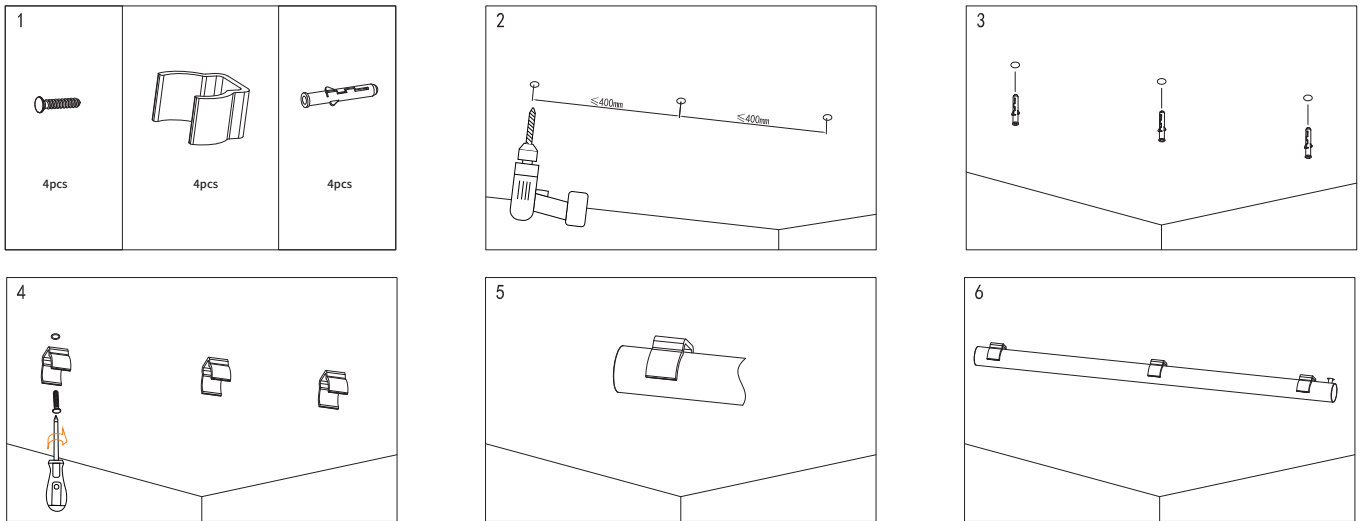

R25 - Surface mounting with PC profile(R25-IA02)

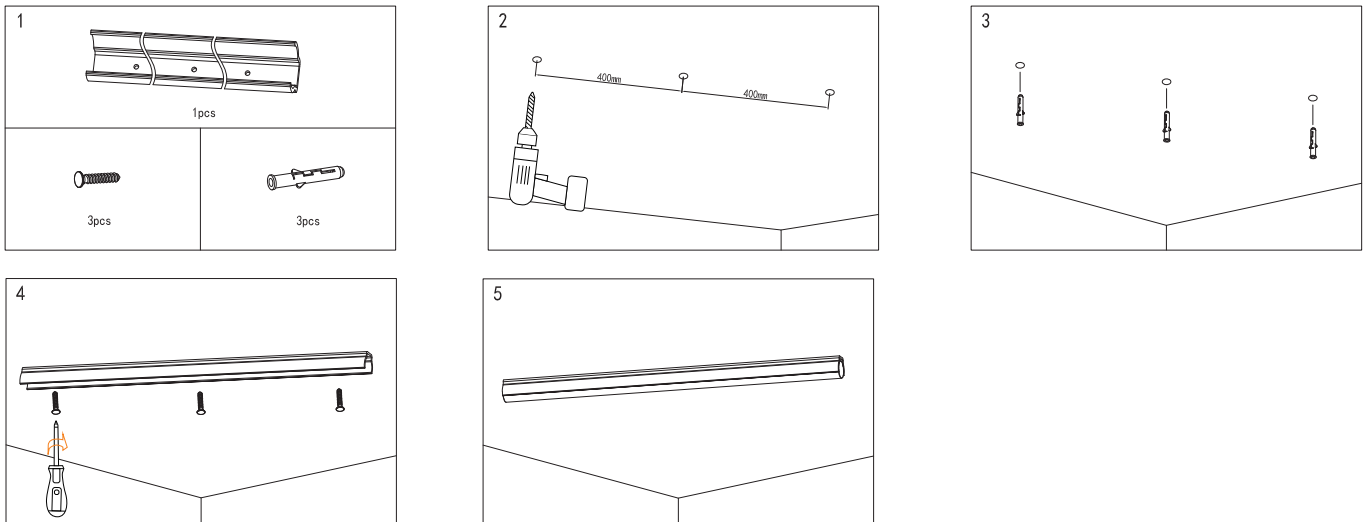

Connection diagram for single color light

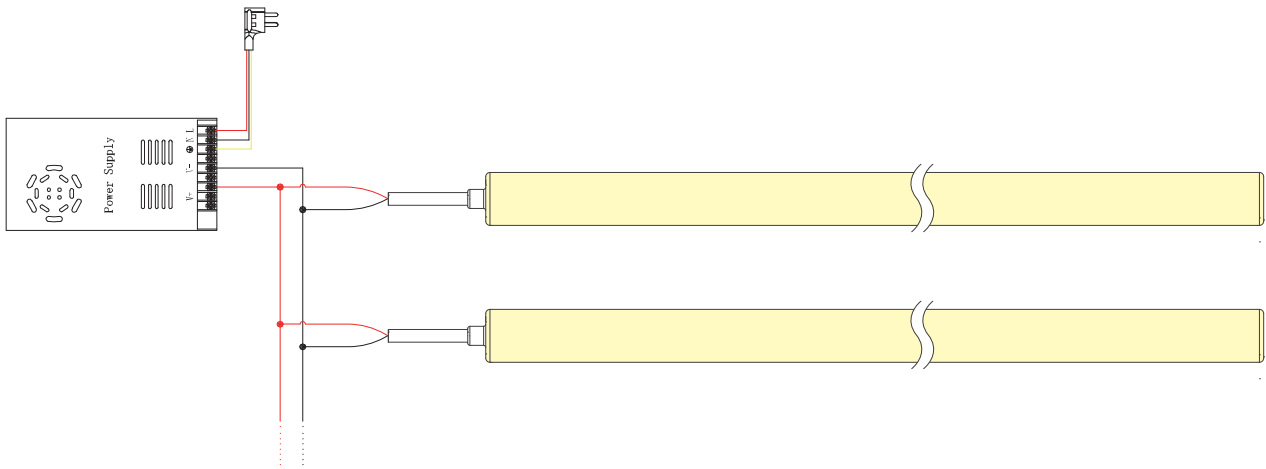

Connection diagram for tunable white light

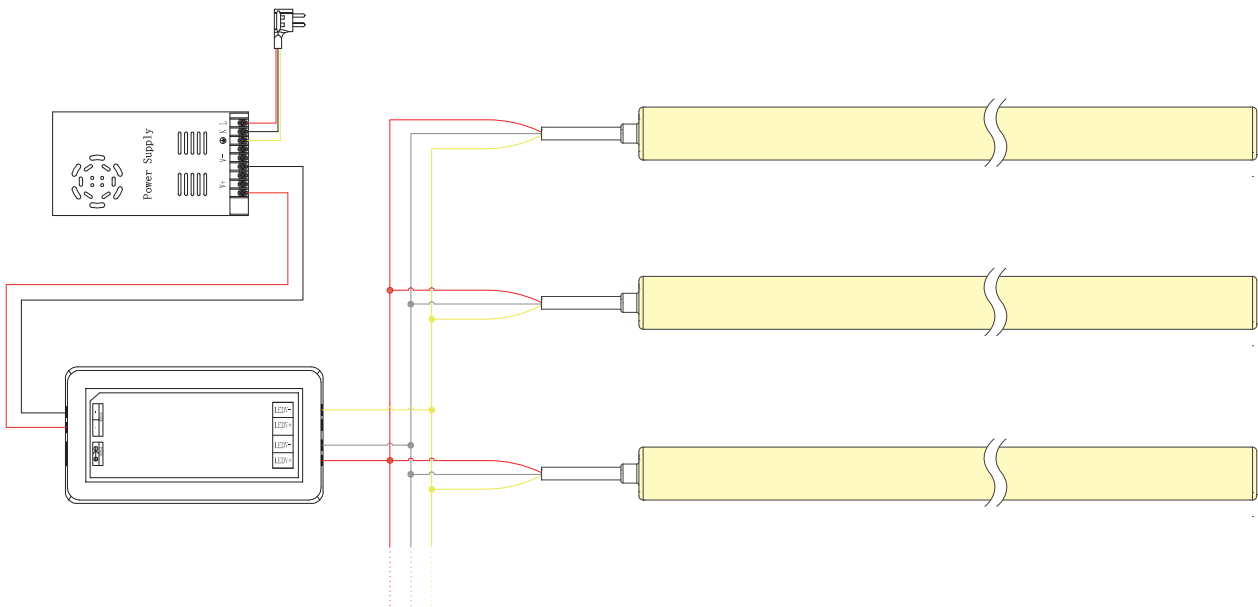

RGB Connection Diagram

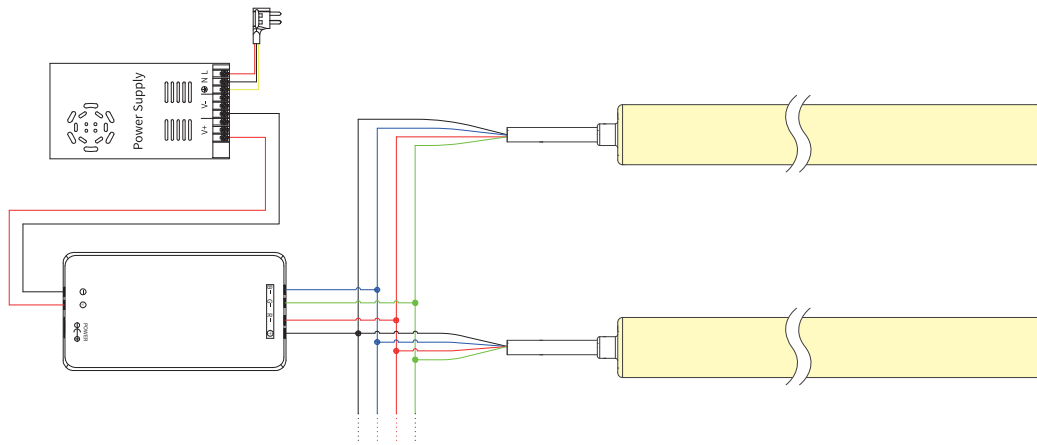

RGBW Connection Diagram

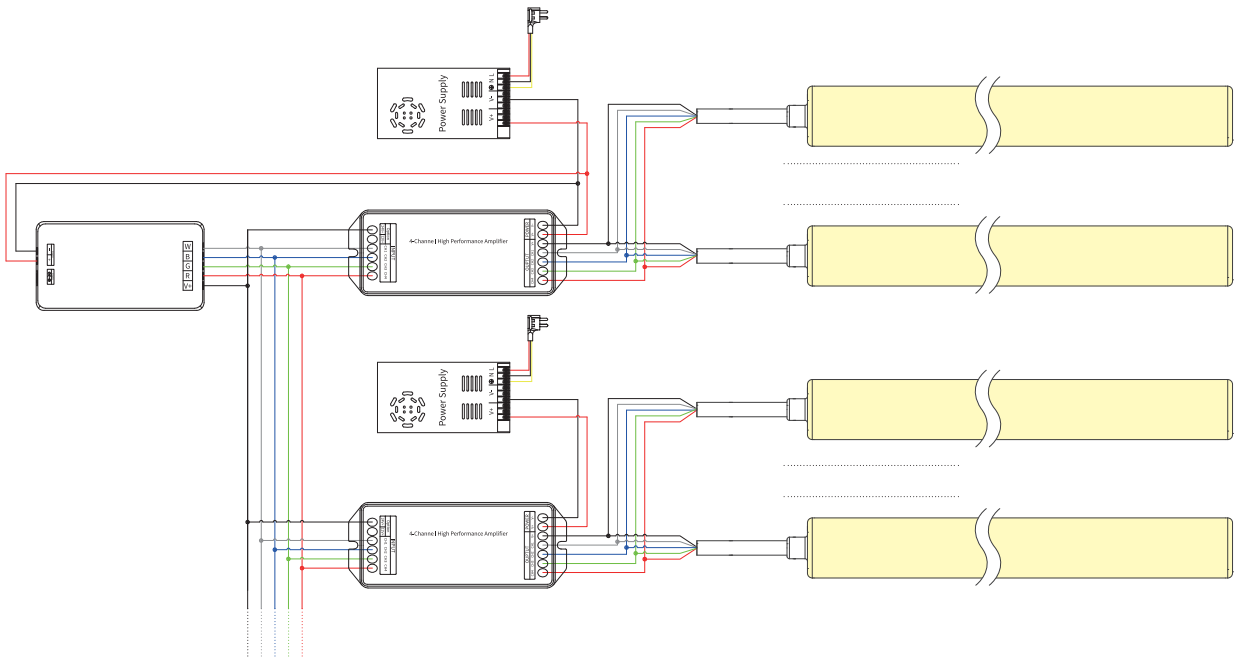

Installation/Use Precautions

- ◆ The unopened products and the unused products after unpacking, should be sealed in packaging bags to avoid long-term exposure.
- ◆ Please use DC24V isolated constant voltage switching power supply with ripple voltage less than 5%. Other types of power supply may damage the product or cause other safety risks.
- ◆ In practical application, the power supply should be retained with a 20% allowance (it is recommended to use only 80% power of the power supply) to ensure the stability of the power supply.
- ◆ Professional operators are recommended to wire and connect the power supply. It is strictly prohibited to connect the power supply with electricity in case of electric shock.
- ◆ Please confirm whether the voltage of the power supply is consistent with the voltage of the product before wiring.
- ◆ Please note the positive and negative sides of the power cord and connect them properly.
- ◆ When using multiple power supply, the situation of parallel connection of the positive pole of the power supply should be avoided. It will lead to instability of the power supply system and damage to the product after long-term operation.
- ◆ If the actual length of the application exceeds the specified length, it will lead to the phenomenon of heating and uneven brightness of the strip due to overload.
- ◆ During installation, please avoid twisting or irregular bending of the strip, and avoid any operation that will scratch the strip, otherwise it may cause irreparable damage to the product.
- ◆ In order to ensure the life and reliability of the strip, please ensure that the diameter of the bending should be greater than 200mm.
- ◆ For the sake of eye protection, please avoid looking directly at the illuminated surface for a long time.
- ◆ Non-professionals are strictly prohibited from installing, disassembling or repairing the strip.
- ◆ Do not use any acid or alkaline adhesive to fix the strip (including but not limited to glass glue, etc.)
- ◆ Different levels of waterproof, different use environment. IP65 is not suitable for immersion application.
- ◆ Due to structural differences, the final visual color of the strip will be slightly different for products of different sizes and specifications under the same color temperature value.
- ◆ Due to the difference in structure, the same color temperature value, different size/specification of the strip, their final visual color will be slightly different. Please make confirmation before use.
- ◆ It is forbidden to cut this product to avoid damage to the strip due to improper operation.
- ◆ Customers are not allowed to cut this product by themselves.

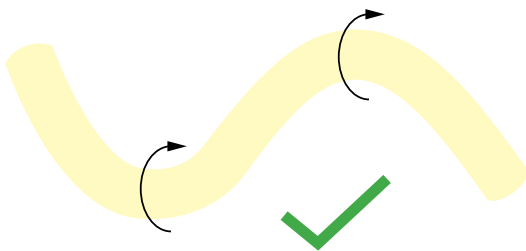

Bending diameter must be greater than 200mm

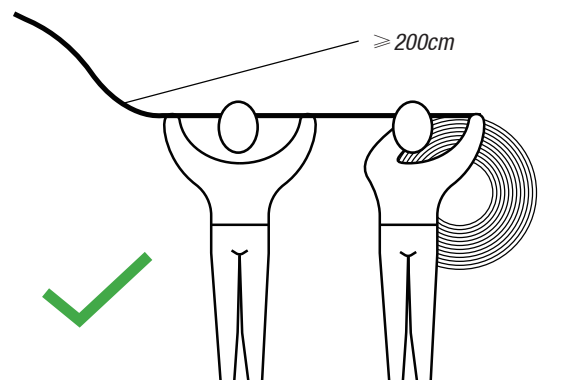

When the length of the strip is longer than 2 meters, have two people work together to install it.

Installation/Use Precautions

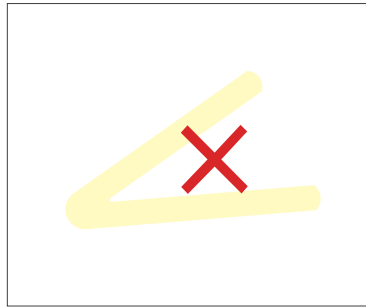

Small Angle bending is prohibited

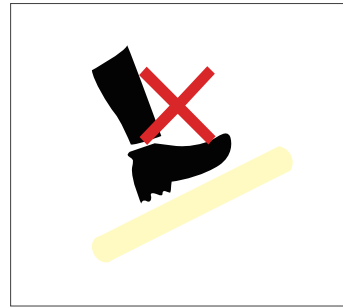

Prohibit trample

Tests show that formaldehyde and benzene substances will make silicone products yellowing.

If the silicone products are used in the indoor environment of new decoration, epoxy floor paint, wall paint, wallpaper adhesive, all kinds of decoration materials, or new furniture, are likely to release formaldehyde and benzene substances. In order to avoid silicone material affected, it is suggested that the use of the environment after the completion of the new decoration, formaldehyde and benzene should be removed first, or it should be ventilated for a period of time before installing the strip.